

ETON 35L GLASS DOOR MINIBAR

SILENT OPERATION

Will not disturb sleeping guests

PELLIER COOLING TECHNOLOGY WITH CONDENSER

Efficient cooling

LEFT OR RIGHT OPENING

Flexible use



LOW-E GLASS

Reflects heat back into the room

R600A REFRIGERANT

Environmentally friendly coolant

INTERIOR LED LIGHT

ADJUSTABLE SHELVING SYSTEM

Can be configured to different sized items

- D energy rating
- Can accommodate a 1L bottle of water/wine
- Adjustable cooling dial

Specification

Black
12.9kg
35L
58W
R600a refrigerant (Non-ammonia coolant)
50mm ventilation gap required
Insulation: Cyclopentane



3 YEAR ELECTRICAL GUARANTEE



HOTEL SPECIFIED



ECO FRIENDLY



ADJUSTABLE COOLING



INTERIOR LED LIGHT



SILENT OPERATION



L + R DOOR OPENINGS



LOW E GLASS



TEMPERED GLASS



60 kWh/annum



32 L



Alco

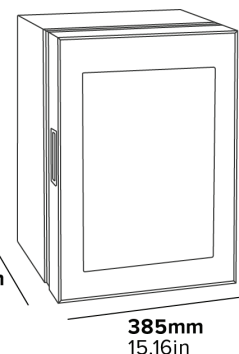

MINIBAR À PORTE EN VERRE ETON DE 35 L

FONCTIONNEMENT SILENCIEUX

Ne dérangera pas les clients pendant leur sommeil

TECHNOLOGIE DE REFRIGERISSEMENT PELTIER AVEC CONDENSEUR

Refrigerissement efficace

OUVERTURE GAUCHE OU DROITE

Utilisation flexible



VERRE LOW-E

Réfléchit la chaleur dans la pièce

RÉFRIGÉRANT R600A

Réfrigérant écologique

ÉCLAIRAGE LED INTÉRIEUR

SYSTÈME D'ÉTAGÈRES AJUSTABLE

Peut-être configuré pour différents objets

- Classe énergétique D
- Peut contenir une bouteille d'eau/vin de 1 L
- Sélecteur de refroidissement ajustable

Spécifications

Noir

12,9 kg

35 L

58 W

Réfrigérant R600a (Réfrigérant non ammoniacal)

Espace de ventilation de 50 mm requis

Isolation: Cyclopentane



3 YEAR GARANTIE ÉLECTRIQUE



CONÇUE POUR LE SECTEUR **HÔTELIER**



ÉCOLOGIQUE



REFROIDISSEMENT **AJUSTABLE**



ÉCLAIRAGE LED **INTÉRIEUR**



FONCTIONNEMENT **SILENCIEUX**



OUVERTURES DE PORTE **GAUCHE ET DROITE**



VERRE **LOW E**



VERRE **TREMPÉ**

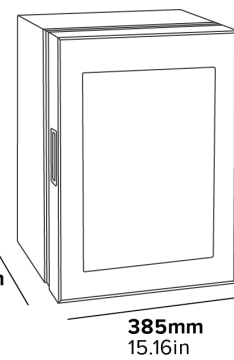
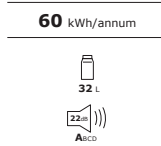
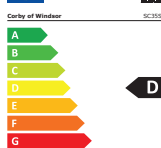

450mm
17.71in

385mm
15.16in

485mm
19.09in

MINIBAR DE PUERTA DE VIDRIO ETON DE 35 L

FUNCIONAMIENTO SILENCIOSO

No perturbará a los huéspedes mientras duermen

TECNOLOGÍA DE ENFRIAMIENTO PELTIER CON CONDENSADOR

Enfriamiento eficiente

APERTURA IZQUIERDA O DERECHA

Uso flexible

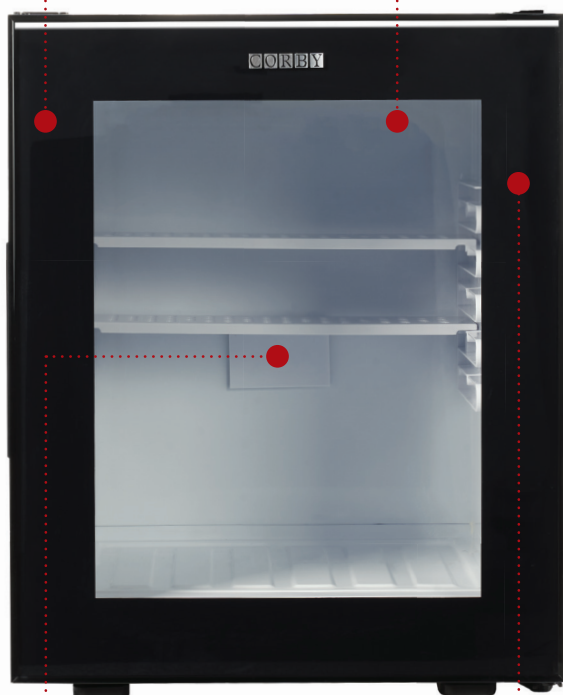

VIDRIO LOW-E

Refleja el calor de vuelta a la habitación

REFRIGERANTE R600A

Refrigerante ecológico

LUZ LED INTERIOR

SISTEMA DE ESTANTERÍAS AJUSTABLE

Puede configurarse para diferentes tamaños de objetos

- Clasificación energética D
- Puede albergar una botella de agua/vino de 1 L
- Selector de enfriamiento ajustable

Especificaciones

Negro
12,9 kg
35 L
58 W
Refrigerante R600a (Refrigerante no amoniacal)
Se requiere espacio de ventilación de 50 mm
Aislamiento: Ciclopentano



3
YEAR
GARANTÍA
ELÉCTRICA



DISEÑADO PARA EL SECTOR
HOTELERO



ECOLÓGICO



ENFRIAMIENTO
AJUSTABLE



LUZ LED
INTERIOR



FUNCIONAMIENTO
SILENCIOSO



APERTURAS DE PUERTA
IZQUIERDA Y DERECHA



**VIDRIO
LOW E**



**VIDRIO
TEMPLADO**

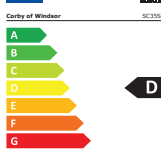

32 L

22dB
A(lco)

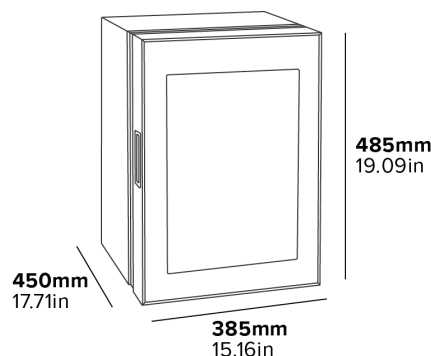

ETON 35 L GLASTÜR-MINIBAR

LEISER BETRIEB

Stört die schlafenden Gäste nicht

PELLTIER-KÜHLTECHNOLOGIE

MIT KONDENSATOR
Effiziente Kühlung

LINKS ODER RECHTS ZU ÖFFNEN

Flexibler Einsatz

LED-INNENBELEUCHTUNG

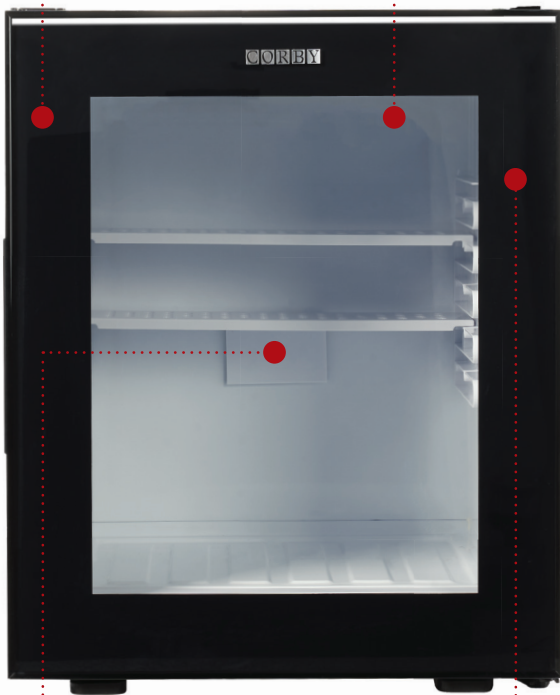

LOW-E-GLAS

Reflektiert die Wärme zurück in den Raum

R600A KÄLTEMITTEL

Umweltfreundliches Kühlmittel

VERSTELLBARES REGALSYSTEM

Kann für verschiedene Größen konfiguriert werden

- Energieklasse D
- Kann eine 1L Flasche Wasser/Wein aufnehmen
- Einstellbares Kühlrad

Beschreibung

Schwarz
12,9 kg
35 L
58 W
Kältemittel R600a (ammoniakfreies Kühlmittel)
50mm Lüftungsspalt erforderlich
Isolierung: Cyclopentan

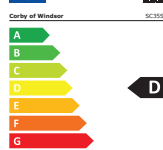

60 kWh/annum

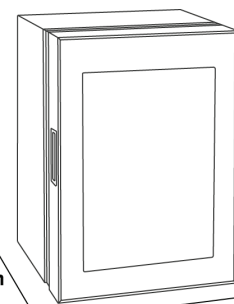

MINIBAR ETON DA 35 L CON PORTA IN VETRO

FUNZIONAMENTO SILENZIOSO

Non disturberà gli ospiti durante il loro riposo

TECNOLOGIA DI RAFFREDDAMENTO PELTIER CON CONDENSATORE

Raffreddamento efficiente

APERTURA SINISTRA O DESTRA

Utilizzo flessibile

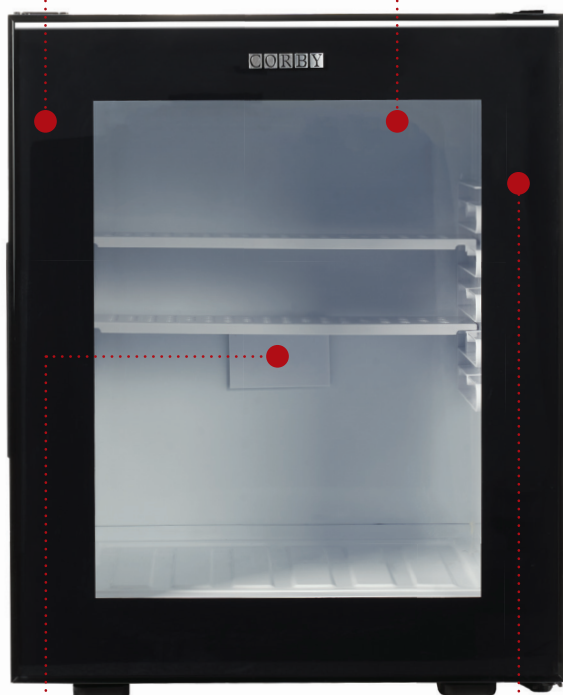

VETRO BASSO AD EMISSIONE

Riflette il calore nella stanza

REFRIGERANTE R600A

Liquido refrigerante ecologico

LUCE INTERNA A LED

SISTEMA DI SCAFFALI REGOLABILI

Può essere configurato per articoli di dimensioni diverse

- Classe energetica D
- Può contenere una bottiglia di acqua/vino da 1 litro
- Quadrante di raffreddamento regolabile

Caratteristiche

Nero

12,9 kg

35 L

58 W

Refrigerante R600a (Refrigerante senza ammoniaca)

È richiesto uno spazio di ventilazione di 50 mm

Isolamento: Ciclopentano



3 YEAR
GARANZIA ELETTRICA



HOTEL SPECIFICATO



ECOLOGICO



RAFFREDDAMENTO REGOLABILE



LUCE INTERNA A LED



FUNZIONAMENTO SILENZIOSO



APERTURE PORTE L/R



VETRO BASSO E



VETRO TEMPERATO

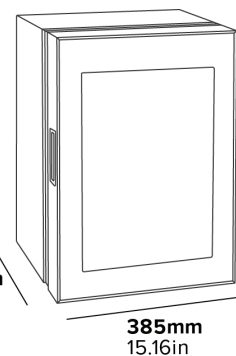
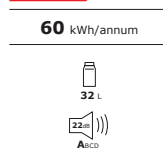

MINIBAR ZE SZKLANYMI DRZWICZKAMI ETON 35 L

CICHA OBSŁUGA

Nie przeszkadza śpiącym gościom

TECHNOLOGIA CHŁODNICZA

PELTIER ZE SKRAPLACZEM
Wydajne chłodzenie

OTWIERANIE

W LEWO LUB
W PRAWO
Elastyczne
zastosowanie

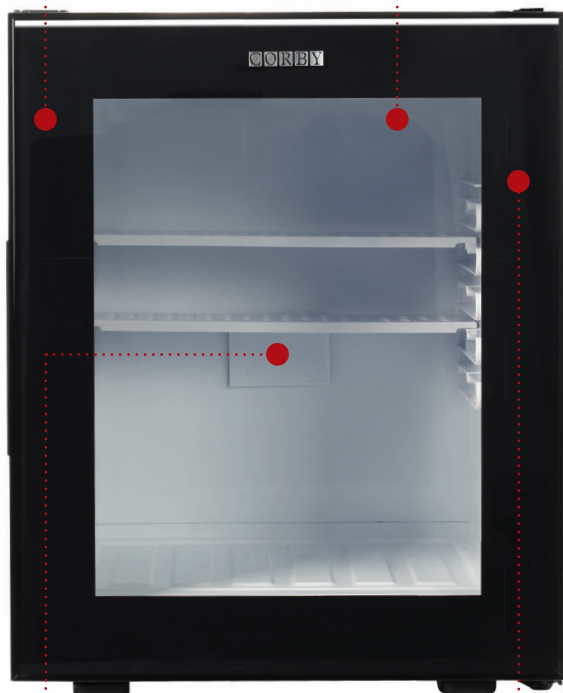

SZKŁO NISKOEMISYJNE

Odbija ciepło z powrotem do pokoju

CZYNNIK CHŁODZĄCY R600A

Przyjazne środowisku chłodziwo

WEWNĘTRZNA LAMPKA LED

SYSTEM PÓLEK REGULOWANYCH

Można skonfigurować pod
przedmioty różnych rozmiarów

- Klasa energetyczna D
- Pomieści butelkę wody/wina 1 L
- Regulowane pokrętko chłodzenia

Specyfikacja

Czarny

12,9 kg

35 L

58 W

Czynnik chłodzący R600a (Chłodziwo bezamoniakowe)

Wymagana luka wentylacyjna 50 mm

Izolacja: Cyklopentan

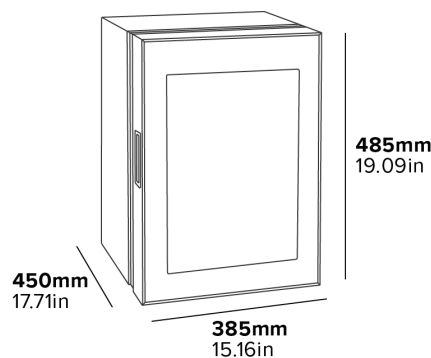
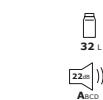
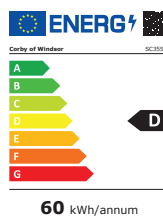

MINIBAR ETON CU UȘĂ DE STICLĂ 35 L

FUNȚIONARE SILENȚIOASĂ

Nu deranjează oaspeții care dorm

TEHNOLOGIE DE RĂCIRE PELTIER CU CONDENSATOR

Răcire eficientă

DESCHIDERE LA STÂNGA SAU LA DREAPTA

Utilizare flexibilă



GEAM LOW-E

Reflectă căldura înapoi în încăpere

AGENT FRIGORIFIC R600A

Agent de răcire ecologic

LUMINĂ INTERIOARĂ CU LED

SISTEM CU RAFTURI REGLABILE

Poate fi configurat pentru articole de dimensiuni diferite

- Clasificare energetică D
- Poate găzdui o sticlă de apă/vin de 1 L
- Cadran reglabil pentru răcire

Specificații

Negru

12.9 kg

35 L

58 W

Agent frigorific R600a (agent de răcire fără amoniac)

Este necesar un spațiu de ventilație de 50 mm

Izolație: Ciclopentan



SPECIAL PENTRU HOTEL



3 YEAR GARANȚIE ELECTRICAL



PRIETENOS CU MEDIUL INCONJURATOR



CAPACITATE DE RĂCIRE AJUSTABILĂ



LUMINA INTERIOARĂ CU LED



FUNCȚIONARE SILENȚIOASĂ



DESCHIDERE LA STÂNGA SAU LA DREAPTA



STICLĂ LOW E



GEAM TRATAT CHIMIC



60 kWh/annum

32 L

22dB

Alco

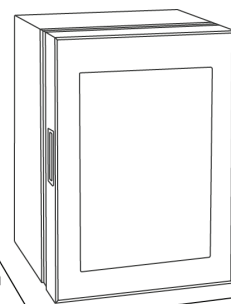

450mm
17.71in

385mm
15.16in

485mm
19.09in

ETON 35 L MINIBAR SE SKLENĚNÝMI DVEŘMI

TICHÝ PROVOZ

Neruší spící hosty

PELTIEROVA TECHNOLOGIE CHLAZENÍ S KONDENZÁTOREM

Účinné chlazení

LEVÉ NEBO PRAVÉ OTEVÍRÁNÍ

Flexibilní použití

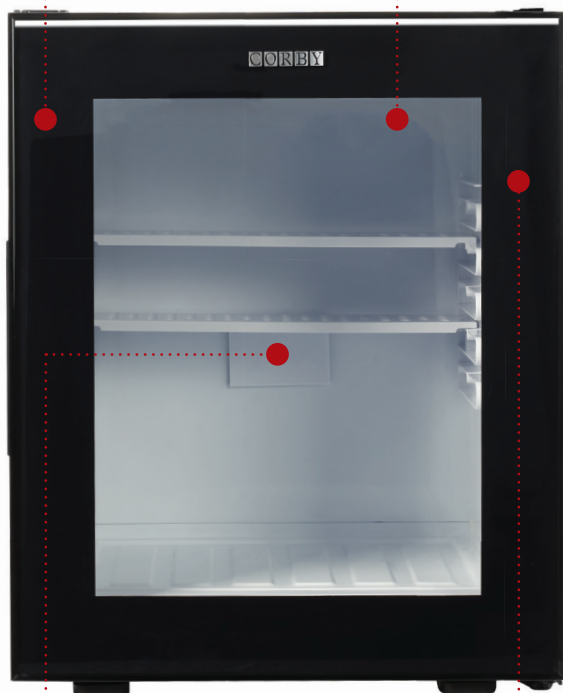

NÍZKOEMISNÍ SKLO

odráží teplo zpět do místnosti

CHLADIVO R600A

Chladicí kapalina šetrná k životnímu prostředí

VNITŘNÍ LED SVĚTLA

NASTAVITELNÝ REGÁLOVÝ SYSTÉM

Lze konfigurovat na různé velikosti položek

- Energetická třída D
- Vejde se do ní 1 L láhev vody/vína
- Nastavitelný volič chlazení

Specifikace

Černá

12,9 kg

35 L

58 W

Chladivo R600a (neamoniakální chladivo)

Vyžaduje se 50 mm větrací mezera

Izolace: Cyklopentan



3
YEAR
ELEKTRICKÁ
ZÁRUKA



5
★
UVEDENÝ
HOTEL



EKOLOGICKY
SETRNĚ



NASTAVITELNÉ
CHLAZENÍ



VNITŘNÍ
LED SVĚTLA



TICHÝ
PROVOZ



L + R DVEŘNÍ
OTVORY



NÍZKÉ
E SKLO



MĚŘENÉ
SKLO

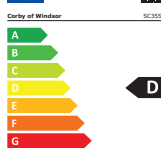

32 L



22dB

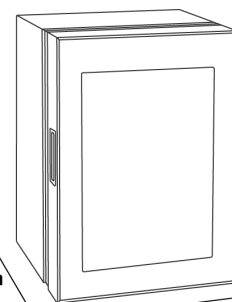

450mm
17.71in

385mm
15.16in

485mm
19.09in