

ASHTON METAL LUGGAGE RACK WITH BACK

TUBULAR STEEL CONSTRUCTION

DURABLE FINISH



DURABLE NYLON STRAPS

FOLDABLE
Easy to store

- Holds up to 50kg

Specification
Chrome & Black
2.5kg

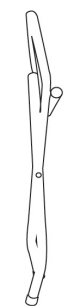

55mm
2.16in

865mm
34.05in

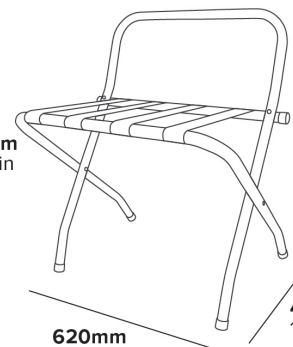

710mm
27.95in

480mm
18.90in

420mm
16.53in

620mm
24.41in