

# HENLEY 45L DRAWER MINIBAR

**PELTIER COOLING TECHNOLOGY WITH CONDENSER**  
Efficient cooling

**INTERIOR LED LIGHT**



**R600A REFRIGERANT**  
Environmentally friendly coolant

**SILENT OPERATION**  
Will not disturb sleeping guests

**ADJUSTABLE DIVIDER SYSTEM**  
Can be configured to different sized items

- F energy rating
- Can accommodate a 1L bottle of water/wine
- Drawer design
- Adjustable cooling dial

**Specification**

Black  
13.6kg  
45L  
58W  
R600a refrigerant (Non-ammonia coolant)  
50mm ventilation gap required  
Insulation: Cyclopentane

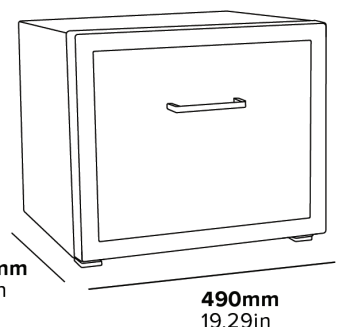
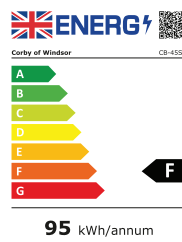

# MINIBAR TIROIR HENLEY DE 45 L

## TECHNOLOGIE DE REFROIDISSEMENT PELTIER AVEC CONDENSEUR

Refroidissement efficace

## ÉCLAIRAGE LED INTÉRIEUR



## RÉFRIGÉANT R600A

Réfrigérant écologique

## FONCTIONNEMENT SILENCIEUX

Ne dérangera pas les clients pendant leur sommeil

## SYSTÈME DE SÉPARATION AJUSTABLE

Peut-être configuré pour différents objets

- Classe énergétique F
- Peut contenir une bouteille d'eau/vin de 1 L
- Design tiroir
- Sélecteur de refroidissement ajustable

### Spécifications

Noir

13,6 kg

45 L

58 W

Réfrigérant R600a (Réfrigérant non ammoniacal)

Espace de ventilation de 50 mm requis

Isolation: Cyclopentane



35 L

19dB

A+++

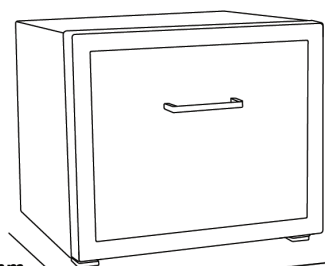

460mm  
18.11in

490mm  
19.29in

425mm  
16.73in

# MINIBAR DE CAJÓN HENLEY DE 45 L

**TECNOLOGÍA DE ENFRIAMIENTO PELTIER CON CONDENSADOR**

Enfriamiento eficiente

**LUZ LED INTERIOR**



**REFRIGERANTE R600A**

Refrigerante ecológico

**FUNCIONAMIENTO SILENCIOSO**

No perturbará a los huéspedes mientras duermen

**SISTEMA DE DIVISIÓN AJUSTABLE**

Puede configurarse para diferentes tamaños de objetos

- Clasificación energética F
- Puede albergar una botella de agua/vino de 1 L
- Diseño de Cajón
- Selector de enfriamiento ajustable

**Especificaciones**

Negro  
13,6 kg  
45 L  
58 W  
Refrigerante R600a (Refrigerante no amoniacal)  
Se requiere espacio de ventilación de 50 mm  
Aislamiento: Ciclopentano

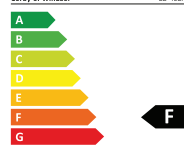

95 kWh/annum

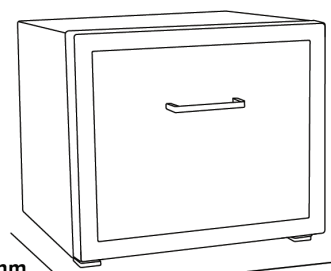

460mm  
18.11in

490mm  
19.29in

425mm  
16.73in

# HENLEY 45 L SCHUBLADEN MINIBAR

**PELTIER-KÜHLTECHNOLOGIE  
MIT KONDENSATOR**  
Effiziente Kühlung

**LED-INNENBELEUCHTUNG**



**R600A KÄLTEMITTEL**  
Umweltfreundliches  
Kühlmittel

**LEISER BETRIEB**  
Stört die schlafenden  
Gäste nicht

**VERSTELLBARES  
TRENNWANDSYSTEM**  
Kann für verschiedene  
Größen konfiguriert werden

- Energiestufe F
- Kann eine 1 L Flasche Wasser/  
Wein aufnehmen
- Schubladen-Design
- Einstellbares Kühlrad

## Beschreibung

Schwarz  
13,6 kg  
45 L  
58 W  
Kältemittel R600a (ammoniakfreies Kühlmittel)  
50mm Lüftungsspalt erforderlich  
Isolierung: Cyclopentan



HOTEL  
SPEZIFIZIERT



3  
YEAR  
ELEKTRISCHE  
GARANTIE



BRITISCHES  
DESIGN



ÖKOFREUNDLICH



EINSTELLBARE  
KÜHLUNG



LED-INNENBELEUCHTUNG



GERÄUSCHLOSER  
BETRIEB

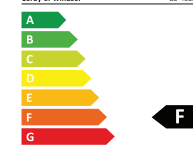

35 L

19dB

A+++

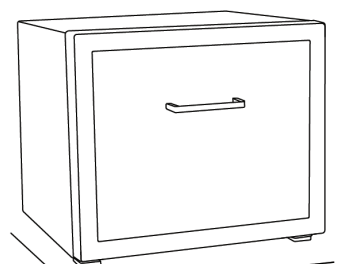

460mm  
18.11in

490mm  
19.29in

425mm  
16.73in



# MINIBAR A CASSETTI HENLEY DA 45 L

**TECNOLOGIA DI RAFFREDDAMENTO PELTIER CON CONDENSATORE**

Raffreddamento efficiente

**LUCE INTERNA A LED**



**REFRIGERANTE R600A**

Liquido refrigerante ecologico

**FUNZIONAMENTO SILENZIOSO**

Non disturberà gli ospiti durante il loro riposo

**SISTEMA DIVISORIO REGOLABILE**

Può essere configurato per articoli di dimensioni diverse

- Classe energetica F
- Può contenere una bottiglia di acqua/vino da 1 litro
- Progettazione del cassetto
- Quadrante di raffreddamento regolabile

**Caratteristiche**

Nero  
13,6 kg  
45 L  
58 W  
Refrigerante R600a (Refrigerante senza ammoniaca)  
È richiesto uno spazio di ventilazione di 50mm  
Isolamento: Ciclopentano



95 kWh/annum

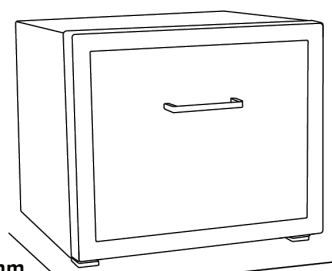

460mm  
18.11in

490mm  
19.29in

425mm  
16.73in

# MINIBAR Z SZUFLADĄ HENLEY 45 L

## TECHNOLOGIA CHŁODNICZA PELTIER ZE SKRAPLACZEM

Wydajne chłodzenie

## WEWNĘTRZNA LAMPKA LED



## CZYNNIK CHŁODZĄCY R600A

Przyjazne środowisku chłodziwo

## CICHA OBSŁUGA

Nie przeszkadza śpiącym gościom

## SYSTEM REGULOWANYCH PRZEGRÓD

Można skonfigurować pod przedmioty różnych rozmiarów

- Klasa energetyczna F
- Pomieści butelkę wody/wina 1 L
- Design szuflady
- Regulowane pokrętko chłodzenia

### Specyfikacja

Czarny

13,6 kg

45 L

58 W

Czynnik chłodzący R600a (Chłodziwo bezamoniakowe)

Wymagana luka wentylacyjna 50 mm

Izolacja: Cyklopentan



Z MYŚLĄ O HOTELACH



3 YEAR GWARANCJA ELEKTRYCZNA



BRYTYJSKI DESIGN



EKOLOGICZNY



REGULOWANE CHŁODZENIE



WEWNĘTRZNA LAMPKA LED



CICHA OBSŁUGA



Corby of Windsor CB-45SA



95 kWh/annum



35 L



A+++

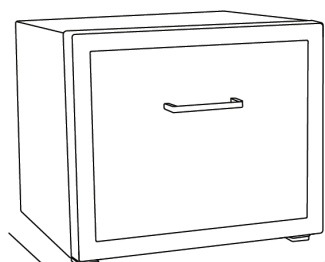

460mm  
18.11in

490mm  
19.29in

425mm  
16.73in

# MINIBAR HENLEY CU SERTAR 45 L

## TEHNOLOGIE DE RĂCIRE PELTIER CU CONDENSATOR

Răcire eficientă

## LUMINĂ INTERIOARĂ CU LED



## AGENT FRIGORIFIC R600A

Agent de răcire ecologic

## FUNȚIONARE SILENȚIOASĂ

Nu deranjează oaspeții care dorm

## SISTEM DE DIVIZARE REGLABIL

Poate fi configurat pentru articole de dimensiuni diferite

- Clasificare energetică F
- Poate găzdui o sticlă de apă/vin de 1 L
- Design sertare
- Cadran reglabil pentru răcire

### Specificații

Negru  
13.6 kg  
45 L  
58 W  
Agent frigorific R600a (agent de răcire fără amoniac)  
Este necesar un spațiu de ventilație de 50 mm  
Izolație: Ciclopentan



SPECIAL PENTRU HOTEL



3 YEAR GARANȚIE ELECTRICAL



DESIGN BRITANIC



PRIETENOS CU MEDIUL INCONJURATOR



CAPACITATE DE RĂCIRE AJUSTABILĂ



LUMINA INTERIOARĂ CU LED



FUNCTIONARE SILENȚIOASĂ

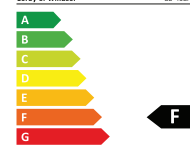

35 L

19dB(A) AECOD

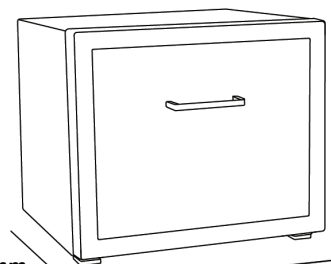

460mm  
18.11in

490mm  
19.29in

425mm  
16.73in

# HENLEY 45 L ZÁSUVKOVÝ MINIBAR

**PELTIEROVA TECHNOLOGIE  
CHLAZENÍ S KONDENZÁTOREM**

Účinné chlazení

**VNITŘNÍ LED SVĚTLA**



**CHLADIVO R600A**

Chladicí kapalina šetrná k životnímu prostředí

**TICHÝ PROVOZ**

Neruší spící hosty

**NASTAVITELNÝ  
DĚLICÍ SYSTÉM**

Lze konfigurovat na různé velikosti položek

- Energetická třída F
- Vejde se do ní 1 L láhev vody/vína
- Konstrukce zásuvek
- Nastavitelný volič chlazení

**Specifikace**

Černá  
13,6 kg  
45 L  
58 W  
Chladivo R600a (neamoniakální chladivo)  
Vyžaduje se 50 mm větrací mezera  
Izolace: Cyklopentan



UVEDENÝ  
HOTEL



3  
YEAR  
ELEKTRICKÁ  
ZÁRUKA



BRITSKÝ  
DESIGN



EKOLOGICKY  
SETRNĚ



NASTAVITELNÉ  
CHLAZENÍ



VNITŘNÍ  
LED SVĚTLA



TICHÝ  
PROVOZ

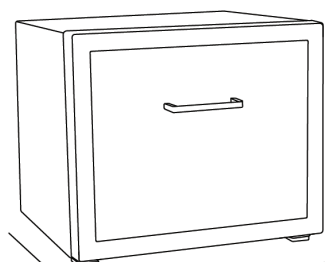
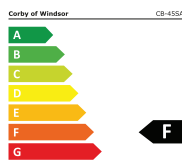

460mm  
18.1in

490mm  
19.29in

425mm  
16.73in