

BURLINGTON GUEST HANGER WITH CLIPS

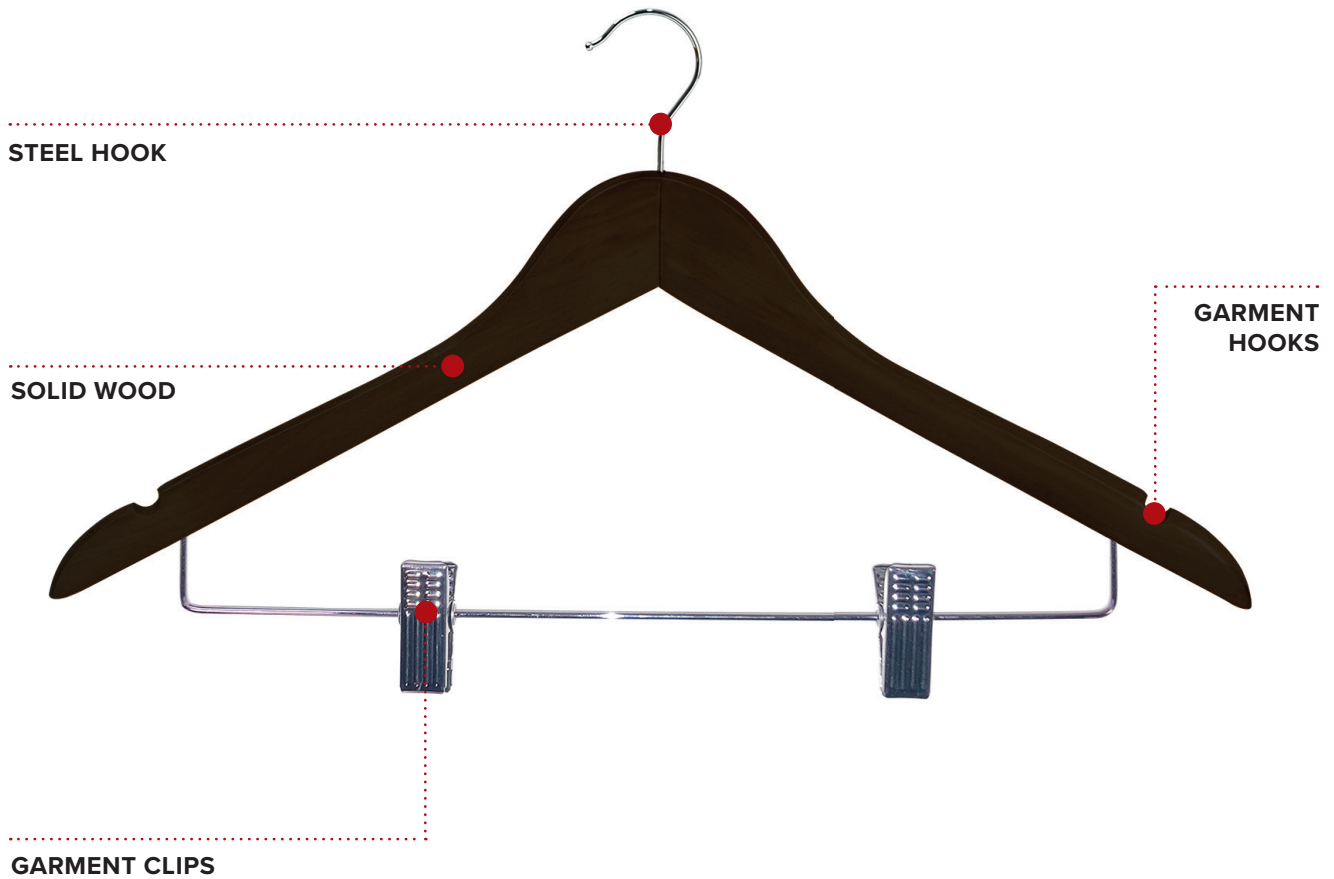

Specification

Black
0.14kg

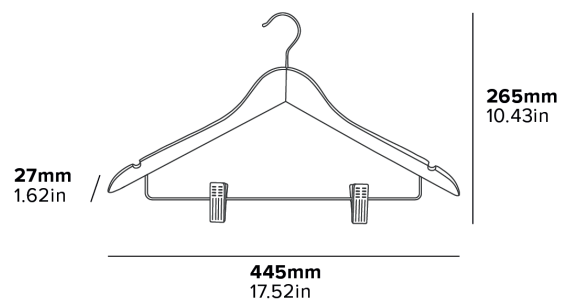

CINTRE D'INVITÉ BURLINGTON AVEC PINCES

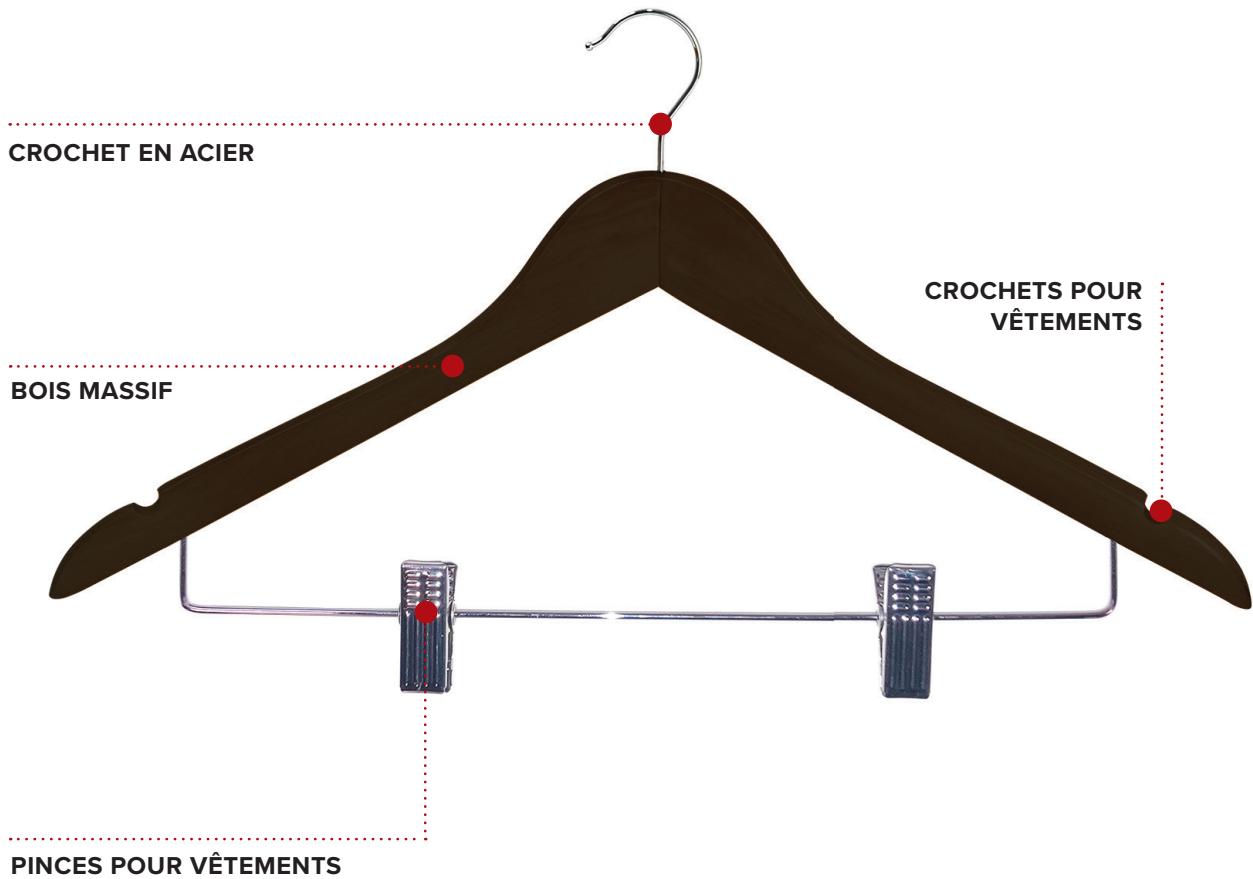

Spécifications

Noir
0,14 kg

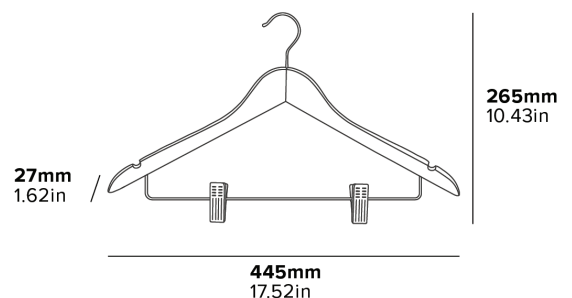

PERCHA DE HUÉSPEDES BURLINGTON CON PINZAS

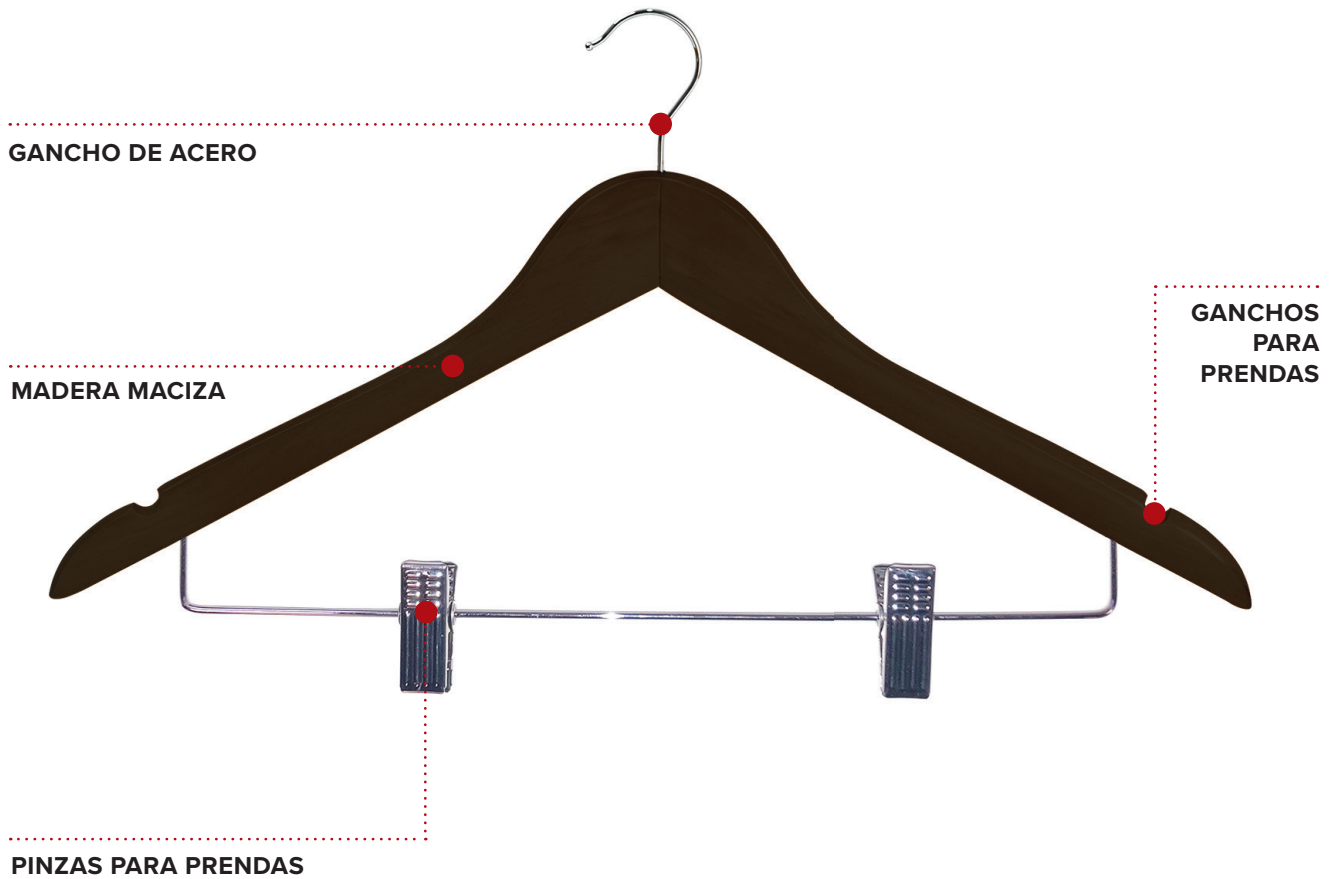

Especificaciones

Negro
0,14 kg

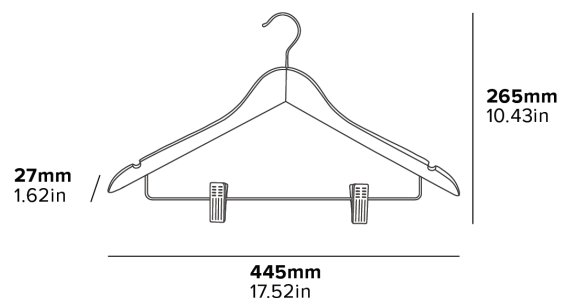

BURLINGTON GARDEROBENHAKEN MIT CLIPS

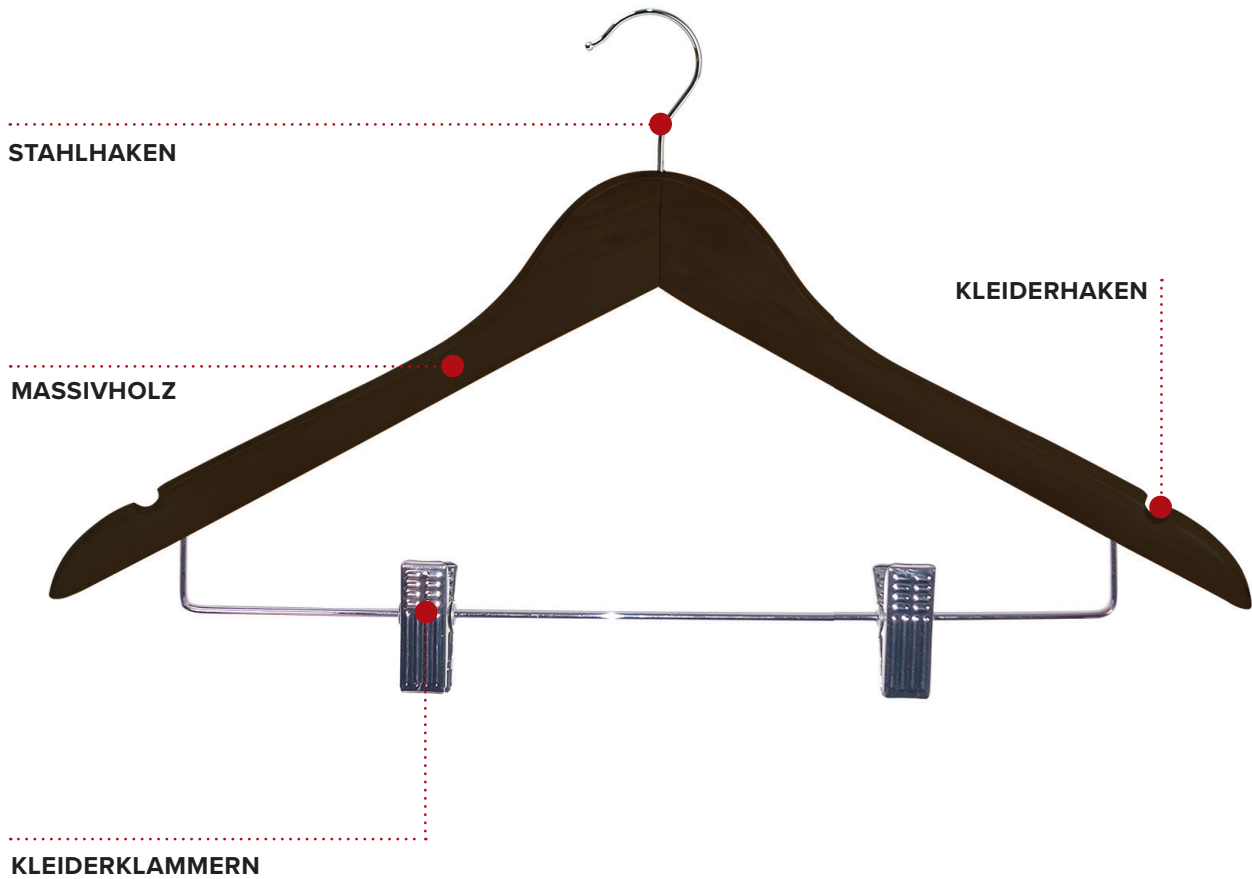

Beschreibung

Schwarz
0,14 kg

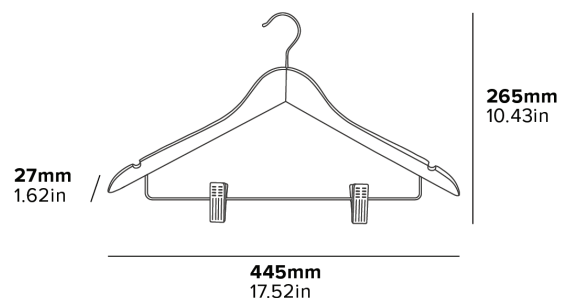

GRUCCIA OSPITI BURLINGTON CON CLIP

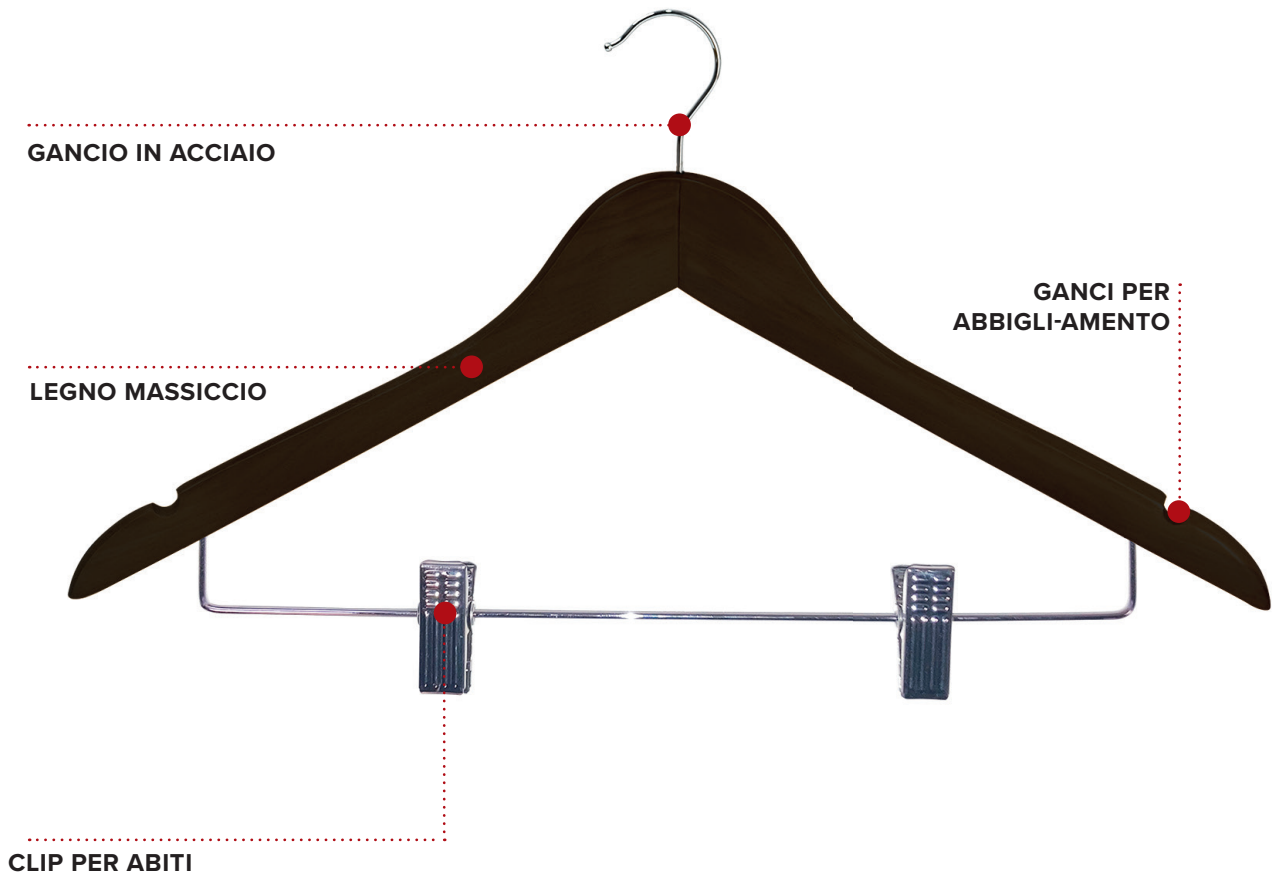

Caratteristiche

Nero
0,14 kg

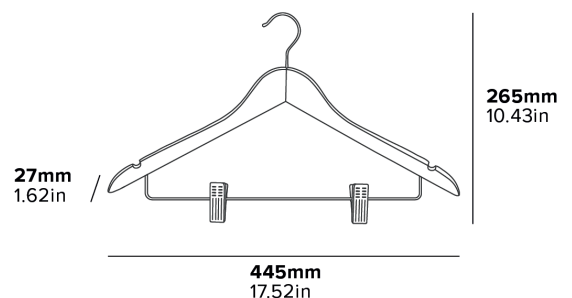

WIESZAK HOTELOWY Z ZACISKAMI BURLINGTON

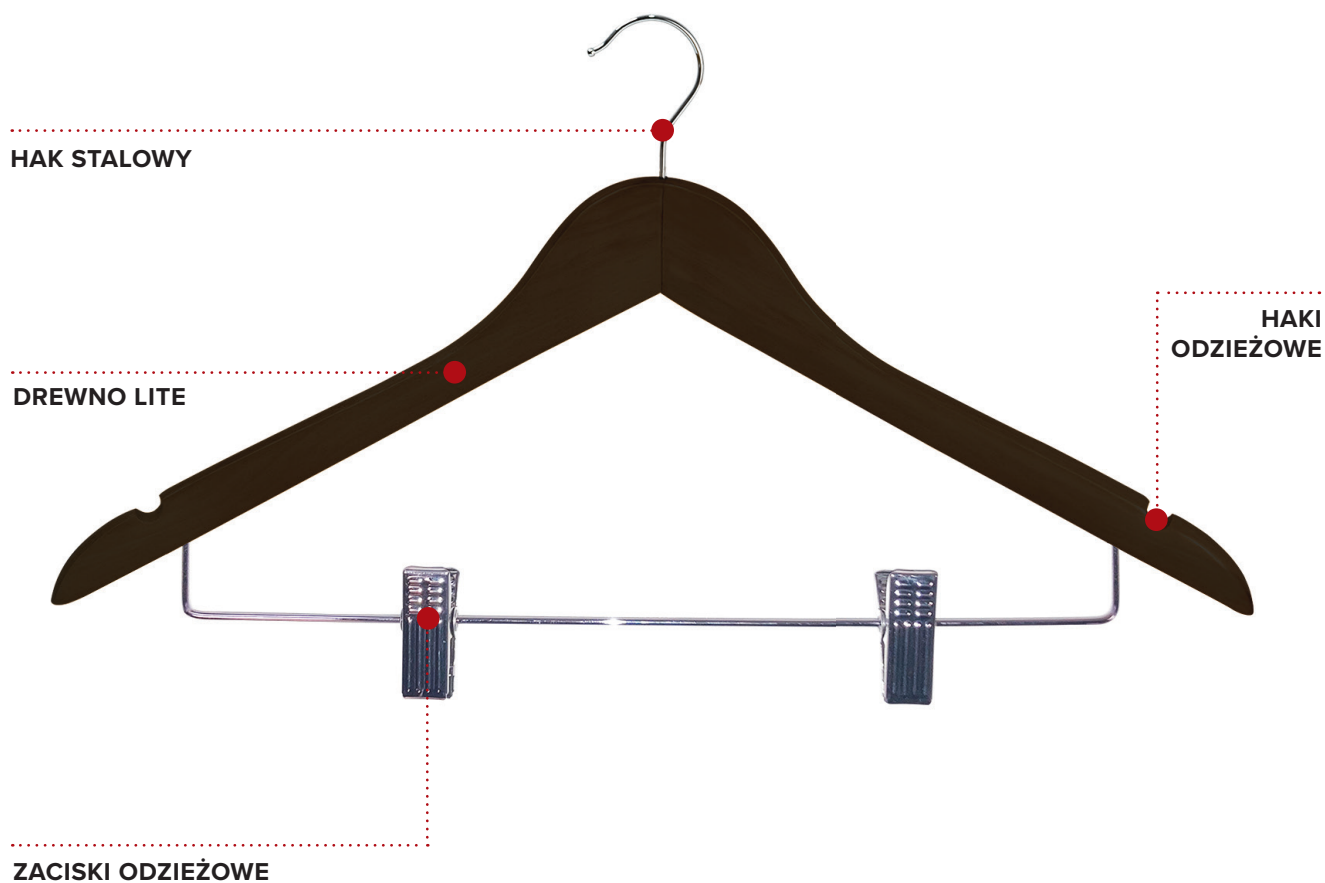

Specyfikacja

Czarny
0,14 kg

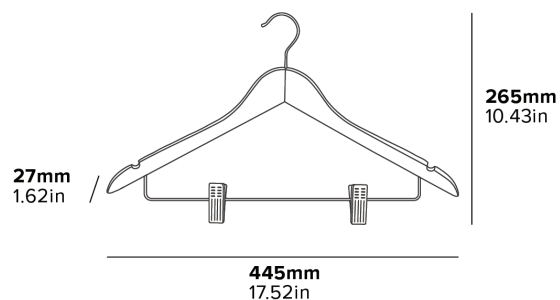

UMERAȘ DE OASPEȚI BURLINGTON CU CLEME

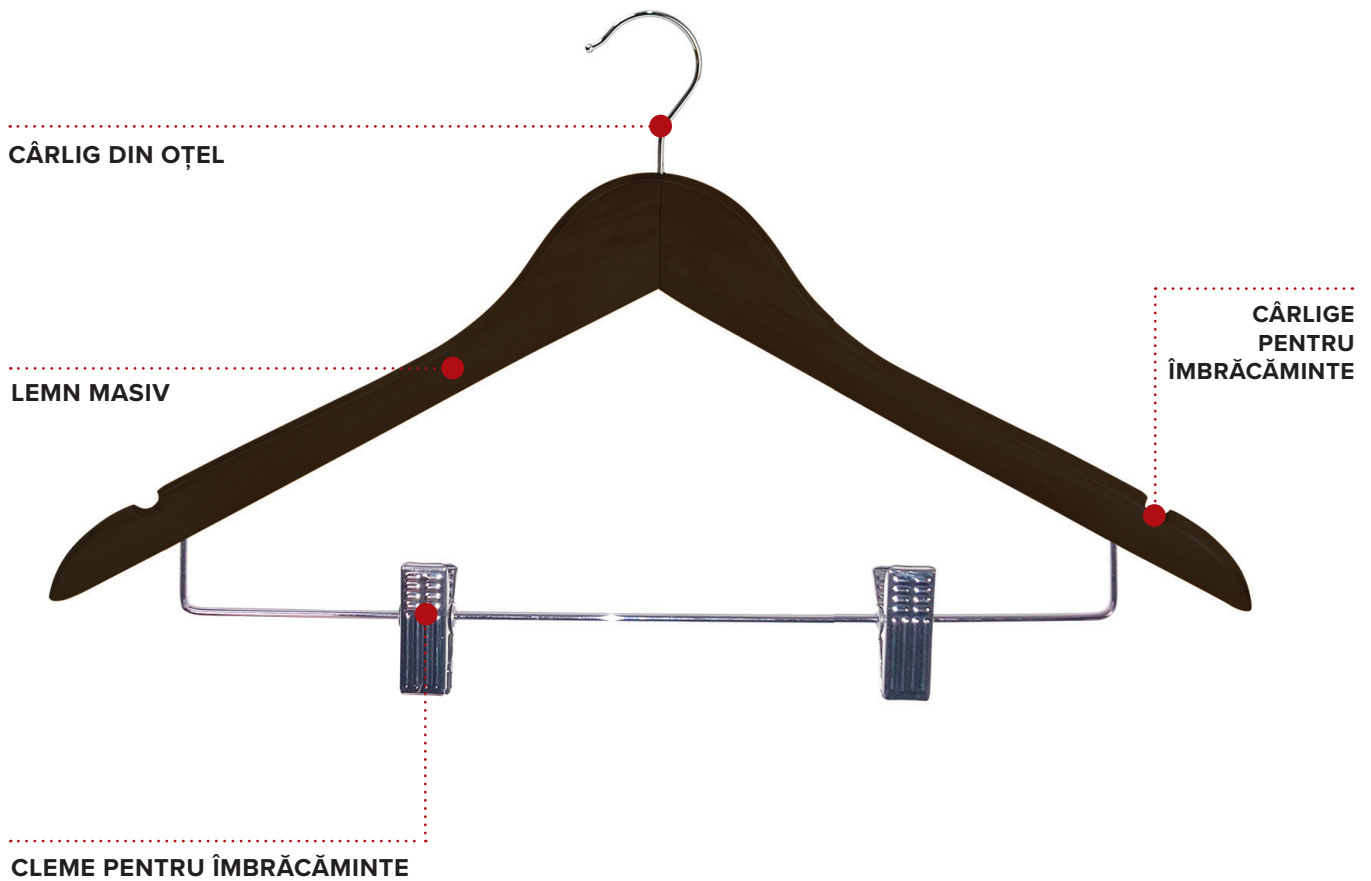

Specificații
Negru
0.14 kg

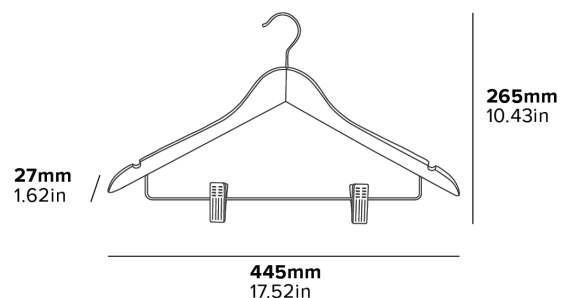

VĚŠÁK PRO HOSTY BURLINGTON S KLIPY

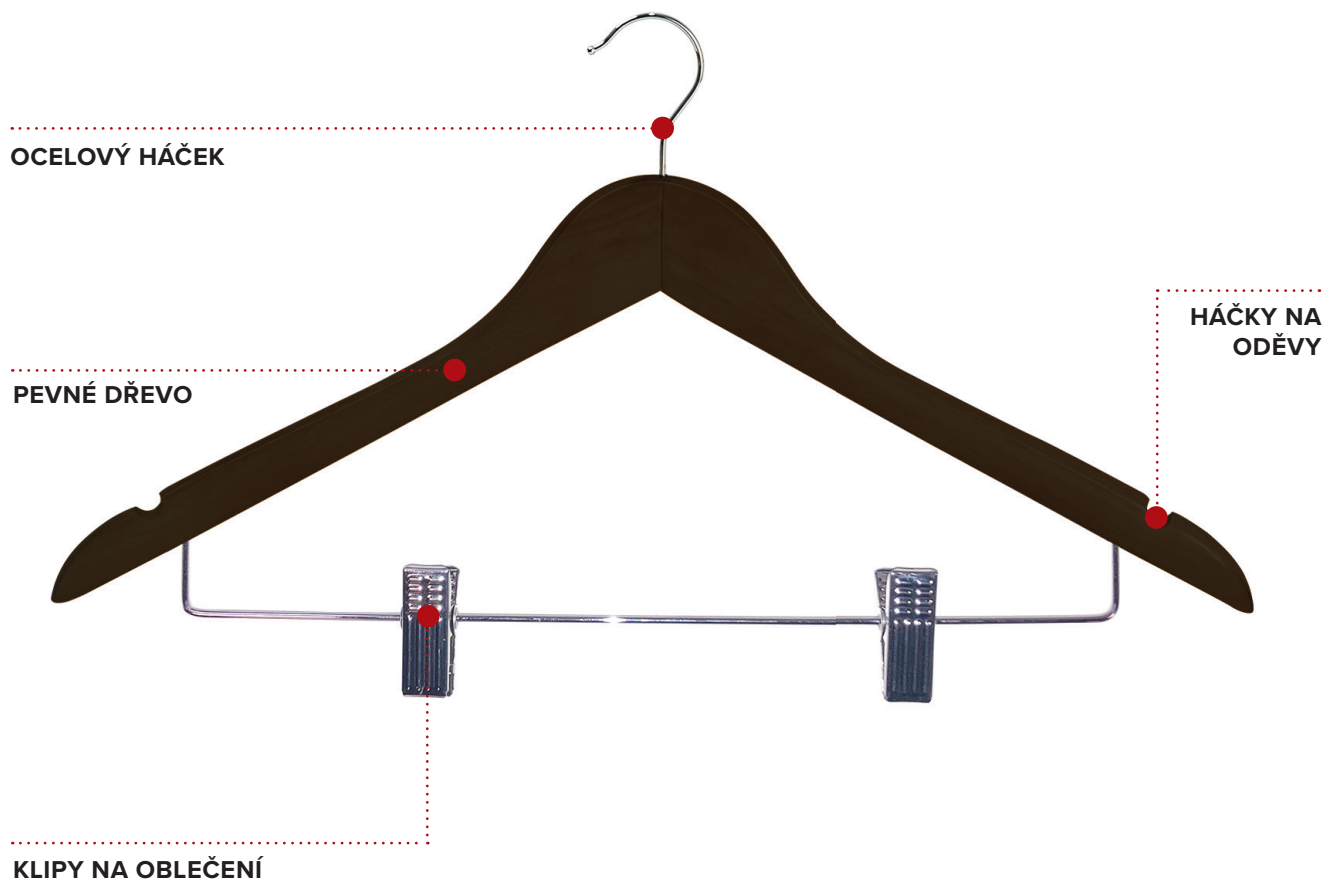

Specifikace

Černá
0,14 kg

